

NELSON EZ PRO™ Instructions

Zone Chart

1 _____	13 _____
2 _____	14 _____
3 _____	15 _____
4 _____	16 _____
5 _____	17 _____
6 _____	18 _____
7 _____	19 _____
8 _____	20 _____
9 _____	21 _____
10 _____	22 _____
11 _____	23 _____
12 _____	24 _____

NELSON

EZ Pro™

INSTALLATION AND PROGRAMMING GUIDE

For EZ Pro Controller Models:

8604	8674	8604R	8674R
8606	8676	8606R	8676R
8608	8678	8608R	8678R
8612	8682	8612R	8682R
8616	8686	8616R	8686R
8520	8690	8620R	8690R
8624	8694	8624R	8694R



THANK YOU for purchasing the **EZ Pro™** electronic irrigation controller. This controller offers great features in the standard models and the added full function radio capability in the "R" models. The **EZ Pro™** is so "EZ", you'll probably be able to install and program this feature-packed controller without instructions. However, before installing and programming the controller, we recommend you read these instructions carefully to take full advantage of all the **EZ Pro™** has to offer.

If you have questions, problems or comments on your new **EZ Pro™** please call our Technical Services Department toll-free at 888-NELSON8.

Leaders in Turf Irrigation Since 1911

NOTE: In our efforts to continually improve and update our products, features and specifications in this manual may change without notice.

TABLE OF CONTENTS

Features	3
Installation	4-8
Terminal Strip	7
Connecting Master Valve or Pump-Start Relay	7
Connecting Rain/Moisture Sensor	7
Connecting Battery & Resetting Controller	8
Programming the EZ Pro™	9-18
Programming Overview	9
Front Panel Layout	10-11
Set Time of Day	12
Set Today's Date	12
Set Current Day	12
Select Zones and Set Their Run Times	12-13
Set Start Times	14
Set % Water Budget	14
Set % Water Budget by Month	15
Scheduling	15-17
Set Water Days Scheduling Option	16
Set Odd/Even Day Scheduling Option	16
Set Interval Scheduling Option	17
Program Review	17
Set Master Valve or Pump	18
Set Rain Delay	18
Turning the Controller Off	18
Advanced Features	19-20
Run a Zone Manually	19
Run a Program Cycle Manually	20
Run a 3 Minute Test (Syringe)	20
Technical Data/Specifications	21-23
Troubleshooting/Service	24
FCC Rules	25
Warranty	26

FEATURES

- Full function programming and manual remote control (on “R” models) through radio transmission to EZ Command Remote Programmer (sold separately)
- EZ Command Radio Module is available factory installed in “R” models or can be added on later
- Nelson exclusive Select and Adjust™ programming
- Non-volatile memory stores programs without AC power or batteries
- Pump Start programmable by zone
- Programmable Rain Delay to 99 days
- Three independent programs
- Four start times per program (12 total starts)
- Stacking start times
- Three scheduling options to suit the needs of plant material or to comply with watering restrictions (days of the week, 1-30 day interval, true odd/even)
- Leap year compatible-automatically includes Feb 29th every four years
- Water budget option reduces or increases watering 0-200 percent
- Advanced water budget to set water budget for each month of the year
- Three test cycles (Manual with ManualAdvance™ feature, Cycle, 3-minute test)
- Programmable run times from one minute to 9 hours 59 minutes
- Poly-fuse self resetting circuit protection

INSTALLATION INSTRUCTIONS

The **EZ Pro™** can be mounted indoors or outdoors. Find a location near a 120V wiring source (230/240V for 8674, 8676, 8678, 8682, 8686, 8690, and 8694 models). Install the **EZ Pro™** near eye level if possible. Use the supplied template to mark and pre-drill pilot holes in the wall. The middle two hole guides in the **EZ Pro™** are vertically aligned for mounting the controller to a stud. (See Template) Insert screws through the holes in the case and screw each into the corresponding pilot hole in the wall.

NOTE: The front panel can be removed to aid in installation by removing the ribbon connector from the interconnect board and pulling the front panel off its hinges.

IMPORTANT NOTE: To comply with FCC RF exposure compliance requirements, the following antenna installation and device operating configurations must be satisfied - The antenna used for this transmitter must be installed to provide a separation distance of at least 5 cm from all persons and must not be co-located or operating in conjunction with any other antenna or transmitter.

Wiring the Transformer

120 VAC in United States, Canada and Mexico; 230 VAC in Europe and 240 VAC in Australia

NOTE: Refer to and follow local codes if different from these instructions.

CAUTION: Disconnect 110V (230/240V for 8674, 8678, 8682, 8686, 8690 and 8694 models) power source before wiring transformer. Complete all wiring and installation before connecting the transformer to power source. This will avoid accidental shorting which could damage the controller.

Power supply cables and cords used for connections are to be a minimum of ordinary duty or greater duty. Live supply wires should be attached together adjacent to the terminal block. Low voltage output cables should be enclosed in conduit affixed to the controller with a suitable adapter. Remove the two screws and lift out the transformer cover to provide access to the internal transformer, bring 120V (or 230/240 for 8674, 8676, 8678, 8682, 8686, 8690,8694) wires up through 1/2" conduit hole in the bottom of the case. (For field connection, AC wires must have an insulation rated at 75°C minimum). Conduit should be secured to the case (follow local codes).

INSTALLATION INSTRUCTIONS

For models 8604, 8606, 8608, 8612, 8616, 8620, 8624 (see figure 1)

Remove the transformer cover by loosening the two screws. Attach AC wires to transformer wires using wire nuts. Also, ensure earth ground wire is attached to green with yellow stripe ground wire. Please check local codes for the grounding requirements in your area. Bundle wire within cable tie loop and tighten cable tie to prevent loose wiring from touching secondary circuits. The transformer is now wired. Replace the transformer cover and the two screws.

DO NOT turn on power yet.

NOTE: Failure to ground unit properly may cause severe damage to the controller and/or personal property and will void warranty.

Figure 1

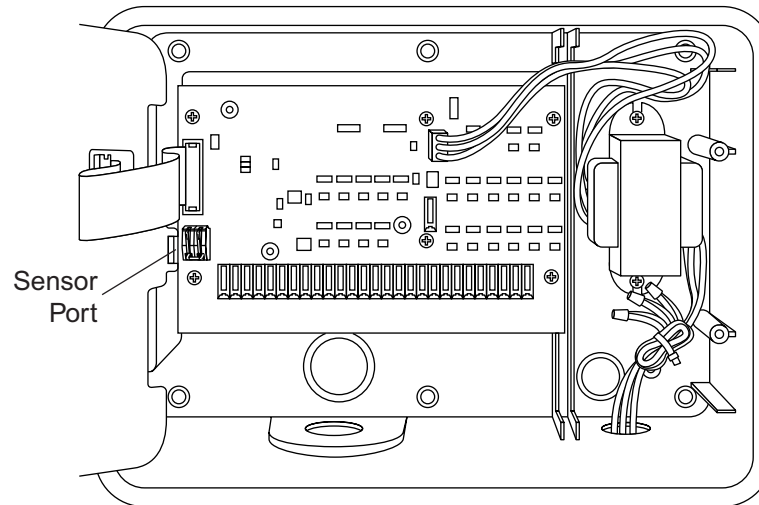

INSTALLATION INSTRUCTIONS

For models 8674, 8676, 8678, 8682, 8686, 8690, 8694 (see figure 2)

Remove the transformer cover by loosening the two screws. Route AC wires to connector provided. Cut and trim wires to install in chassis mount connector. Tighten the screws. (For Australia an extra clamp has been provided.) Observe proper polarity of wires as you install them (ie. L1, L2 and ground). The transformer is now wired. Replace the transformer cover and the two screws. **DO NOT** turn on power yet.

NOTE: Failure to ground unit properly may cause severe damage to the controller and/or personal property and will void warranty.

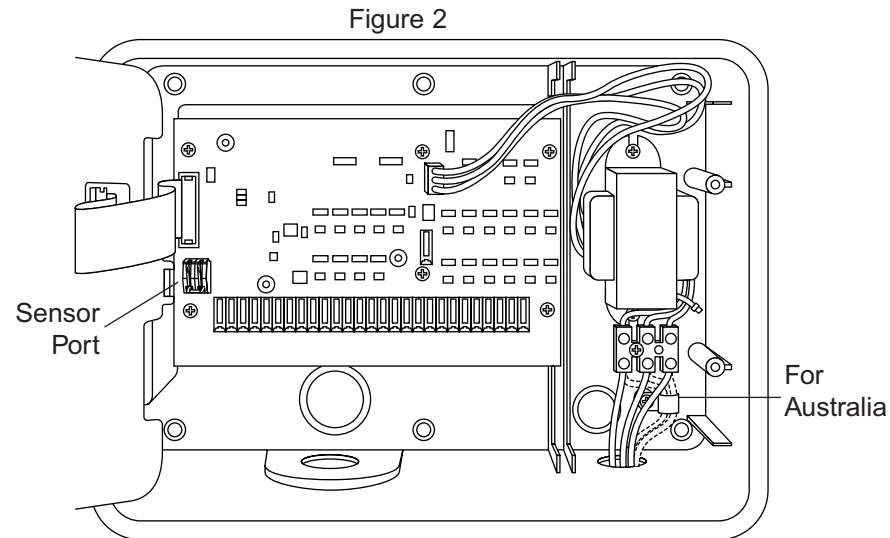

INSTALLATION INSTRUCTIONS

Terminal Strip

All zone, pump and sensor wire connections made inside the **EZ Pro™** utilize tool-less connectors. Pull the lever into the upper position and insert the wire into the bottom. Push the lever down to lock in the wire. The terminal strips in the **EZ Pro™** controller accept 14 AWG (1.6mm) wire or smaller.

Connecting Master Valve or Pump-Start Relay

The **EZ Pro™** is equipped with a shared circuit to operate either a pump-start relay or a master valve. Connect one wire from the pump-start relay to COM (common) on terminal strip, the other to PMP/MV (pump/master valve) on the terminal strip. Refer to the pump-start relay manufacturer's instructions for specific installation details.

Connecting Rain/Moisture Sensor

The **EZ Pro™** is equipped to operate a sensor with normally-closed leads. The sensor port on the **EZ Pro™** is the first tool-less connector on the interconnect board (see Figure 2). To install a sensor, remove the factory-installed jumper wire from the sensor connector on the terminal strip and insert the sensor wires. Refer to the sensor manufacturer's instructions for specific installation details. (See figure 2)

If a sensor has suspended watering, the sensor indicator segment will appear on the LCD. The symbol will go off when the sensor has dried out. The **EZ Pro™** will resume operation based on the selected program.

INSTALLATION INSTRUCTIONS

Connecting the batteries and starting the controller

Remove the battery access door from the rear panel. Insert two new AA Alkaline (LR6 in Europe) batteries to the battery clips and install the battery access door. The batteries enable the **EZ Pro™** to be programmed without AC power and maintain the real time clock in the event of a power outage. If the batteries are not installed, the controller will lose real time in the event of a power outage. The batteries should be replaced once a year.

NOTE: Since all programs are stored in non-volatile memory, you will not lose program settings during a power failure - even if there is no battery installed.

CAUTION: Use AA alkaline batteries only. An AA NiCad battery may leak or explode causing personal injury or property damage.

Close the front panel, being sure not to damage wires. If wires are stiff, you may find it helpful to pre-bend them. Turn on the power source.

You're now ready to start programming!

PROGRAMMING INSTRUCTIONS

Programming Overview

The **EZ Pro™** can be programmed under AC power or powered from the two AA alkaline batteries. If equipped with an EZ Command Radio module the **EZ Pro™** can be programmed from the EZ Command Remote Programmer. Before programming the **EZ Pro™**, it may be helpful to become familiar with some general programming guidelines:

- If a segment(s) on the LCD is flashing, it means that it can be changed by the user.
- When using \triangle or ∇ keys, hold the button three seconds to start a fast scroll.
- Be sure the appropriate program letter is displayed when you are programming; program changes are specific to the program letter displayed on the LCD.
- There is no "ENTER" key. Key-presses and dial settings are stored automatically for you.
- If you make a programming change while a program is running, the program terminates immediately. The new program starts at the next start time scheduled.
- When not running, the controller displays the current time and the current day.
- During manual operations, there is a 5-second delay before the operation begins. During this time, you can change your settings. Each time you make a change, the delay resets to 5 seconds.
- MANUAL, CYCLE, and 3 MINUTE TEST procedures only operate with the Program dial set in the AUTO position.
- After a test procedure runs, the controller reverts back to the AUTO procedure and runs the next program scheduled.
- The test procedures ignore the sensor connection; this allows you to water or run your program even if the sensor has suspended operation.

PROGRAMMING INSTRUCTIONS

Front Panel Layout

Looking at the front panel (see figure 3), you see a large LCD, 4 rubber buttons, one large rotary dial, and two small rotary dials. The rubber buttons are marked **SELECT** and **ADJUST** and are the heart of Nelson's exclusive **SELECT&ADJUST™** programming. The keys are identified with $\triangleleft/\triangleright$ for increasing or decreasing the segment you're working on.

SELECT&ADJUST™ works on the principle that you first **SELECT** what you want to set, and **ADJUST** the variables of what you selected. For example, if you want a run time of 10 minutes on zone 5, you would use the **SELECT** $\triangleleft/\triangleright$ keys to select zone 5 and, once on zone 5, you would use the **ADJUST** $\triangleleft/\triangleright$ keys to set the run time to 10 minutes.

There are instances when only **SELECT** or only **ADJUST** are required. They will be explained in this guide where appropriate.

PROGRAMMING INSTRUCTIONS

FIGURE 3

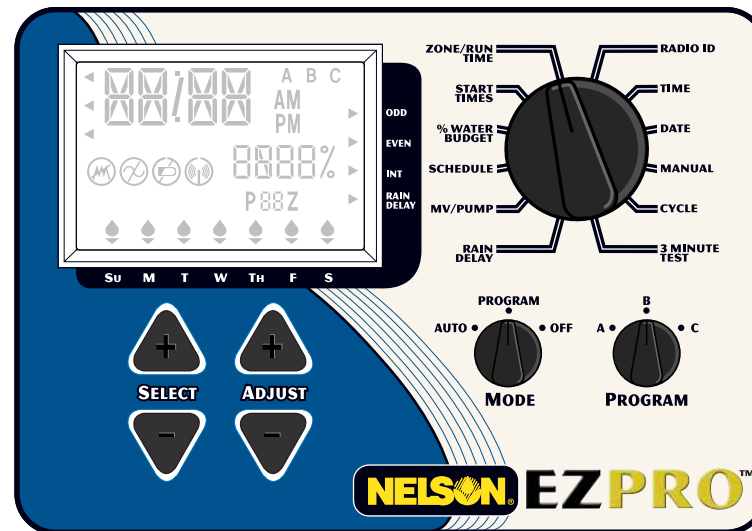



NOTE: The MODE dial must be in the PROGRAM position.

NOTE: Every time the \blacktriangle or \blacktriangledown key is pressed, the display will increase or decrease one unit. Hold the \blacktriangle or \blacktriangledown key for three seconds to initiate a fast scroll.



NOTE: Please refer to the Technical Data section for an explanation of the LCD segments.

PROGRAMMING INSTRUCTIONS

Set Time of Day



Turn the large dial to the **TIME** position. Press **SELECT**  to select between hours, minutes, and 12/24 hour mode. Press **ADJUST**  to scroll to the correct time or adjust between 12/24 mode.

Set Today's Date and Current Day of the Week

Turn the large dial to the **DATE** position. Press **SELECT**  keys to select between day, month and year positions. Press **ADJUST**  keys to scroll to the current date. The correct day of the week will automatically show on LCD screen when today's date is adjusted. The **EZ Pro™** controller is leap year compliant.

Select Zones and Set Their Run Times

A zone run time determines the duration a zone will run.

Turn the large dial to the **ZONE/RUN TIME** position. Turn **PROGRAM** dial to choose program A, B or C. Press **SELECT**  to choose the zone you want for the selected program (A, B, or C). With the zone number displayed on the LCD, press **ADJUST**  to adjust the RUN TIME for that zone. RUN TIMES can be set from 1 minute to 9 hours 59 minutes. Continue selecting zones and adjusting their run times until you have all the zones you want in the selected program.



PROGRAMMING INSTRUCTIONS

After the last zone and before the first zone, a RUN TIME summation is provided. This is useful for determining the total run time for a program. The LCD displays the letters "ALL" and a total RUN TIME is displayed. The time displayed is a summation of all the RUN TIMES for the selected program (100% water budget). (ex. A program has a run time of 5 minutes on zone 1; 12 minutes on zone 2; and 6 minutes on zone 4. The display at this position displays ALL and a run time of 23 minutes).

PROGRAMMING INSTRUCTIONS

Set Start Times

A **START TIME** is the time of day a program will start running. The **EZ Pro™** allows four start times per program.

Turn the large dial to the **START TIMES** position. Press **SELECT**  to select the start time you want to set (1, 2, 3, or 4). Press **ADJUST**  to set the time of day the program will start. Repeat as needed.

Start Time Stacking

The **EZ Pro™** will stack start times if your program watering times overlap another start time. The additional start time will begin when the first cycle finishes.

Set % Water Budget

% WATER BUDGET changes the duration of run times in a program by the percentage entered 0 - 200% (i.e., a 10 minute run time at 50% water budget will run 5 minutes). This feature is useful when changes in weather occur. If it is unusually dry, you may want to extend your run time for each zone in a program. With **% Water Budget**, you can change one number, and all run times in the program are adjusted. If 24 hours of run time is exceeded 24 hr will flash on the LCD.

Turn the large dial to the **% WATER BUDGET** position. A % symbol will appear on the LCD to let you know you are working on the **% Water Budget** amount. Press **ADJUST**  to choose the desired percentage amount.





PROGRAMMING INSTRUCTIONS

If % WATER BUDGET is set for 110% or greater, the **EZ Pro™** will split the run time in half to reduce runoff. Half of the calculated run time will operate for each zone in that program, followed by the second half of the run time for each zone.

Remember, % WATER BUDGET is changeable by program. If you have programming in A, B, and C, you must enter three water budget values if you want every program to be changed.

Set Water Budget by Month (Advanced feature)

The EZ Pro™ allows you to set % WATER BUDGET by month. This feature allows you to customize your program by month over the year to allow for hot dry months and cooler wetter months.

Turn the large dial to the % **WATER BUDGET** position. Press and hold **SELECT**  and **SELECT**  together for 2 seconds. Use the **SELECT**  to select months 1-12. Use the **ADJUST**  to choose the desired percentage amount from 0-200. If 0 is chosen no watering will take place in that month.

Set the Watering Schedule

A quick note on scheduling and the EZ Pro™...

The **EZ Pro™** controller has three scheduling options:









- **WATER DAYS**, or daily, lets you choose which days of the week you want to water (i.e., Monday, Wednesday, Friday only).
- **ODD/EVEN** tells the controller to water on either the odd or even days of the month (i.e., the controller will water on the 31st and the 1st when an ODD schedule is chosen).
- **INTERVAL** waters every X number of days (from 1 to 30 days) (i.e., water every 3 days, waters every 10 days, etc.). A value of 1 in an interval schedule means to water every day. When using the interval option, you have the flexibility to tell the controller what day to start the interval program on (up to 30 days out).

PROGRAMMING INSTRUCTIONS

NOTE: The MODE dial must be in the PROGRAM position to set a schedule.



The LCD will display the currently scheduled program (default is all WATER DAYS.) The SELECT  keys will scroll the LCD display through each of the scheduling positions WATER DAYS, ODD, EVEN, INTERVAL, and INTERVAL START DATE. Be sure the PROGRAM dial is set on the program you want to change (A, B, or C) and that you want to change the current schedule. A scheduling option is chosen after you press a button, either SELECT or ADJUST. The old schedule is replaced with the new one. It's easy to program a schedule with the following procedures.

Set Water Days Scheduling Option

Turn the large dial to the **SCHEDULE** position. Use the **SELECT**  till the raindrops appear above the days of the week. Press the **ADJUST**  button to select that day for watering or press **ADJUST**  for non-watering days. A flashing  indicator appears over the day you're about to set. Raindrops  appear over selected days to water. The  indicator automatically moves one day to the right after an **ADJUST**  or  key press. Continue selecting or deselecting the days you want the controller to water until you have your 7-day calendar set.

NOTE: Programming a WATER DAYS schedule deletes any other schedule for the selected program.





Set Odd/Even Day Scheduling Option

Turn the large dial to the **SCHEDULE** position. The last scheduling option chosen for the current program appears on the LCD. To set either an ODD or an EVEN schedule press the **SELECT**  button till an arrow appears on the LCD next to the appropriate schedule (ODD or EVEN). A DATE must be set for odd/even watering). The **SELECT**  buttons act as toggle keys and will toggle between odd or even.

NOTE: Programming an ODD/EVEN schedule deletes any other schedule for the selected program.

PROGRAMMING INSTRUCTIONS

Set Interval Scheduling Option

Turn the large dial to the **SCHEDULE** position. The last scheduling option chosen for the current program appears on the LCD. Press **SELECT**  to scroll to the interval days position. An arrow will appear on the LCD next to INT (Interval). Use the **ADJUST**  to choose interval days between watering (1-30). The date displayed is day one of the interval schedule. (Today's date if one has been set). To change day 1 date use **SELECT**  to go to the interval start date position. As needed, change the date for day one of the interval schedule with **ADJUST**  (can only be set up to 30 days out).

Repeat the above procedures for each program (A, B, or C), as you require.

That's it! Your **EZ Pro™** is now programmed. Turn the **MODE** dial to the **AUTO** position to run the program you entered.

NOTE: Programming an INTERVAL schedule deletes any other schedule for the selected program.



PROGRAM REVIEW

To review the current program, Turn the **MODE** dial to the **PROGRAM** position and turn the large dial to the setting you wish to review (i.e., turn the large dial to TIME to review the time set for the controller). When you need to view different zones or run times (1, 2, 3), use the **SELECT**  buttons only.



NOTE: Since you are in the program mode, the potential exists to change the program accidentally.

PROGRAMMING INSTRUCTIONS

Set Master Valve or Pump

You can turn on or off the Pump or Master valve output by zone with the **EZ Pro™**. Turn the large dial to the **MV/PUMP** position. Use the **SELECT**  keys to choose the zone. Use the **ADJUST**  to turn the **MV/ PUMP** output on or off when that zone is running. The LCD will show the zone number and either on or off. When watering the zones selected off will not run the MV/ PUMP.

Set a Rain Delay

If you wish to suspend watering for a specified time (from 1-99 days) due to rainy weather or other conditions, the **EZ Pro™** has this option. A Rain Delay can be programmed for Program A, B, C, Programs AB, BC, AC or ABC. Turn the large dial to the **RAIN DELAY** position. The LCD will display the RAIN DELAY arrow and the days of delay. Use the **SELECT**  to choose one of the following; Program A, B, C, Programs AB, BC, AC or ABC. Use the **ADJUST**  to choose the number of days from 1-99 to suspend watering. Turn the **MODE** dial back to **AUTO**. After the specified period (from 1-99 days) the EZ Pro™ will return to automatic watering at the next programmed start time. During any delay period the RAIN DELAY arrow will blink.

TURNING THE CONTROLLER OFF

Turn the **MODE** dial to the **OFF** position. This suspends all watering operations (including manual/test procedures) from operating. The clock continues to maintain the current time and date and your program(s) is retained until you want to run your program(s) again. To run your program, turn the **MODE** dial back to the **AUTO** position.

NOTE: **The non-volatile memory of the EZ will maintain your program without power. If a battery is not present and AC power is lost, the real time for the clock will be lost. The time will need to be reprogrammed.**

ADVANCED FEATURES



The **EZ Pro™** incorporates three manual/test procedures for checking the function of the controller or allowing you to bypass the current program to water immediately. The following section will show you how to set up the controller to:

- run a zone manually
- run a program manually
- run a 3 minute test of every programmed zone



NOTE: All test procedures are run with the MODE dial in the AUTO position. This allows the controller to reset to the AUTO setting after running a manual/test procedure. It also allows you the ability to walk away from the controller after setting up a manual/test procedure and not have to come back to reset the controller to AUTO.

NOTE: All manual/test procedures ignore the sensor connection. Therefore, you can water utilizing one of the manual/test procedures even if the sensor has suspended your scheduled program.

Run a Zone Manually

Turn the large dial to the **MANUAL** position. The default of zone 01 and 00:10 minutes will be flashing (recall that this means you can change them). Press **SELECT**  to select the zone number that you want to run. Press **ADJUST**  to set the run time for the selected zone. The controller will delay 5 seconds before starting the zone.

ADVANCED FEATURES

The **EZ Pro™** incorporates Nelson's **ManualAdvance™** feature in the MANUAL procedure. **ManualAdvance™** allows you to cease the currently running zone and immediately advance to any new zone you select. With the MANUAL procedure running a zone, press **SELECT**  to advance to a new zone. The last entered run time will be displayed. Press **ADJUST**  to enter a new run time for the new zone (the controller will delay 5 seconds before starting the new zone).

Run a Program Cycle Manually

Turn the large dial to the **CYCLE** position. The current program letter will flash. To change to a different program, turn the PROGRAM dial to the desired program (A, B, or C). The controller will delay 10 seconds before starting the selected program. After running, the controller resets to the AUTO procedure.

NOTE: CYCLE runs your current program immediately. Changes cannot be made to the program in the CYCLE procedure.

Run a 3 Minute Test (Syringe)

Turn the large dial to the **3 MINUTE TEST** position. A B C will flash on the LCD (they cannot be changed). This is to let you know the controller will review all three programs and run a 3 minute test on only those zones that have been programmed. We call this **SmartSyringe™**.

This feature allows the controller to skip zones that have not been programmed. These may be zones that are not hooked-up, hence, saving your pump (if equipped).

TECHNICAL DATA

1. Transformer

24 VAC internal transformer; 30 VA, 1.25A for zones and logic. The transformer can run a pump or master valve and two zone valves, maximum.

2. Surge Protection

600 watts TVS across secondaries. (see Circuit Breaker below)

3. Sensor Operation

The **EZ Pro™** is configured to operate the controller with or without a sensor. Sensors must have normally closed connections (leads). The factory-installed jumper wire must be in place if no sensor is used.

4. Zone Lines

The **EZ Pro™** will operate a maximum of three (3) solenoids concurrently, providing one is the pump/master valve. Each zone output can operate one or two solenoids.

I inrush .52A max

I hold .33A max

5. Temperature Range

Operating: -5° to +55° C (23° to 131° Fahrenheit)

Storage: -30° to +85° C (-22° to 185° Fahrenheit)

TECHNICAL DATA

6. Display

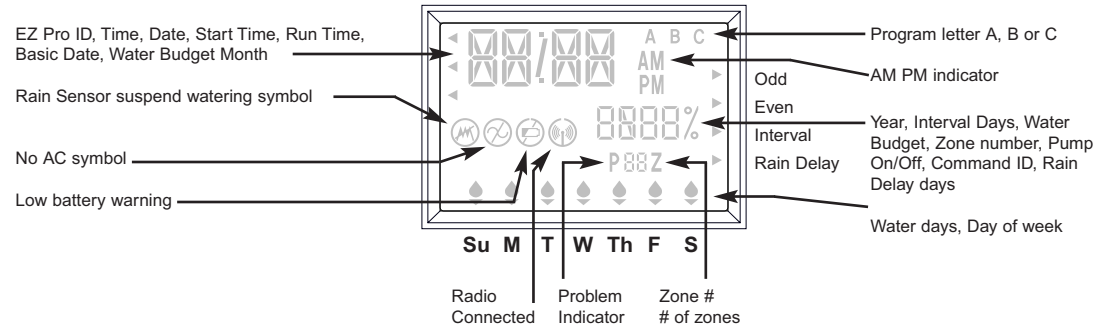

7. Batteries

Two (2) AA (LR6 in Europe) Alkaline batteries are required. **Do not use NiCad batteries.**

8. Program Retention

Non-volatile memory is used to retain programs when battery and AC power are lost. The non-volatile memory is updated when the program is changed and at 10 minute intervals. Non-volatile memory will operate for a minimum of 5 years, worst case.

9. Case Dimensions (approx.)

9" H x 12" W x 5" D (23 cm x 30,5 cm x 12,5 cm) (lid is removable without tools)

TECHNICAL DATA

10. Default Program

12:00 A.M.

Sunday

Date is 01/01 2000

No Run Times (zone 01, —:—)

No Start Times (start number 01, —:—)

100% Water Budget

Every day watering schedule

Mode dial is at OFF position

Program dial is on A program

5 second delay between zones (cannot be changed)

11. Circuit Breaker

An electronic poly-switch is incorporated on the interconnect PCB of the controller. This type of circuit breaker does not require resetting or replacement by the user.

TROUBLESHOOTING/SERVICE

SYMPTOM	POSSIBLE CAUSE	SOLUTION
No output to zone, pump, master valve or no AC indicator ☒ lit	<ul style="list-style-type: none"> AC disconnected 	<ul style="list-style-type: none"> check AC source, if AC is not detected by the controller, the no AC indicator will be lit ☒
no AC and blank display	<ul style="list-style-type: none"> no battery or dead battery 	<ul style="list-style-type: none"> replace battery and press reset
LCD is blank	<ul style="list-style-type: none"> no AC and no battery ribbon cable is disconnected 	<ul style="list-style-type: none"> install battery to regain use of display, check AC to ensure output to field ensure ribbon cable between the front panel and controller board is connected at both ends
"M-X" appears on the LCD when trying to run a zone manually	<ul style="list-style-type: none"> MODE dial is in program position 	<ul style="list-style-type: none"> position the MODE dial in the AUTO position to run a zone manually
"C-X" appears on the LCD when trying to CYCLE a program	<ul style="list-style-type: none"> MODE dial is in program position 	<ul style="list-style-type: none"> position the MODE dial in the AUTO position to cycle a program
"S-X" appears on the LCD when trying to run a 3 MINUTE TEST	<ul style="list-style-type: none"> MODE dial is in program position 	<ul style="list-style-type: none"> position the MODE dial at the AUTO position to run the 3 Minute Test procedure
The controller won't run a 3 MINUTE TEST	<ul style="list-style-type: none"> No programs on A, B, or C 	<ul style="list-style-type: none"> enter a program with run times for the zones you need. The 3 MINUTE TEST only runs those zones with programmed run times on them
P with a zone number appears on LCD	<ul style="list-style-type: none"> Wires not connected or short in wires or solenoid More than 2 solenoids connected to a zone 	<ul style="list-style-type: none"> Check field wiring, check solenoid, replace solenoid
ALL 24HR flashing on LCD	<ul style="list-style-type: none"> Greater than 24 hours of run time programmed 	<ul style="list-style-type: none"> Check zone run times and WATER BUDGET percentage
Controller is not watering and RAIN DELAY arrow appears on LCD	<ul style="list-style-type: none"> RAIN DELAY is programmed into EZ PRO 	<ul style="list-style-type: none"> Turn large dial to RAIN DELAY position and Mode dial to Program, check number of days on LCD. Adjust as desired
RADIO CONNECT symbol appears on LCD	<ul style="list-style-type: none"> Controller is radio connected to an EZ Command Programmer 	<ul style="list-style-type: none"> Turning any dial will disconnect
Rain Sensor symbol on	<ul style="list-style-type: none"> Rain sensor is activated or if no rain sensor installed, the jumper is missing 	<ul style="list-style-type: none"> Check to see if jumper is installed if there is no rain sensor

FCC RULES

This electronic irrigation controller generates and uses radio frequency energy and if not installed and used properly, that is, in strict accordance with the manufacturer's instructions, may cause interference to radio and television reception. It has been type tested and found to comply with the limits for a Class B computing device in accordance with the specifications in Subpart J of Part 15 of FCC Rules, which are designed to provide reasonable protection against such interference in a residential installation. However, there is no guarantee that interference will not occur in a particular installation. If this controller does cause interference to radio or television reception, which can be determined by turning the controller off and on, the user is encouraged to try to correct the interference by one or more of the following measures:

- Reorient the receiving antenna

- Relocate the controller with respect to the receiver

- Move the controller away from the receiver

- Plug the controller into a different outlet so that the controller and receiver are on different branch circuits

If necessary, the user should consult the dealer or an experienced radio/television technician for additional suggestions.

The user may find the following booklet prepared by the Federal Communications Commission helpful:

"How to Identify and Resolve Radio-TV Interference Problems"

This booklet is available from the U.S. Government Printing Office, Washington, DC 20402. Stock No. 004-000-00345-4.

CANADIAN RADIO INTERFERENCE REGULATIONS

NOTE: This digital apparatus does not exceed the Class B limits for radio noise emissions from digital apparatus set out in the radio interference regulations of the Canadian Department of Communications.

WARRANTY

Limited Warranty

L.R. Nelson Corporation ("Nelson") warrants all electronic products to be free of defects in material and workmanship for a period of two (2) years from the original date of purchase. In the event of such defects, Nelson will repair or replace, at its option, the product or the defective part.

This warranty does not extend to damage to a Nelson product or part resulting from accident, misuse, alteration, neglect, abuse, improper installation or normal wear and tear, or to exterior appearance and color. This warranty extends only to the original user of the Nelson product.

If defect arises in a Nelson product or part within the warranty period, you should contact your installing contractor, Nelson retailer, distributor, or L.R. Nelson Corporation at one of the following locations:

One Sprinkler Lane
Peoria, IL 61615
888-NELSON-8
Fax (309) 692-5847

4780 Eucalyptus Ave.
Chino, CA 91710
(800) 800-0993
Fax (909) 631-5025

5660 Commerce Drive; Units 2,3
Orlando, FL 32839-2978
(800) 743-1020
Fax (407) 648-0924

Nelson may, at its option, require that the product or part be returned to a Nelson service point or your retailer or distributor. Nelson will determine whether the claimed defect is covered by the warranty. If coverage is found, the product will be repaired or replaced. Please allow 4 to 6 weeks for completion of repairs or replacement and return of the product or part. If a product or part is replaced, the replacement is warranted only for the remainder of the original product or part warranty period.

This warranty gives you specific legal rights, and you may also have other rights which vary from state to state. L.R. Nelson Corporation does not authorize any person to create for it any other obligation or liability in connection with Nelson products.

TO THE EXTENT ALLOWED BY LAW, ANY IMPLIED WARRANTY OR MERCHANTABILITY OR FITNESS FOR A PARTICULAR PURPOSE APPLICABLE TO THE NELSON PRODUCTS IS LIMITED IN DURATION TO THE DURATION OF THESE WRITTEN WARRANTIES. NEITHER L.R. NELSON CORPORATION NOR ITS DISTRIBUTORS OR DEALERS SHALL BE LIABLE FOR LOSS OF TIME, INCONVENIENCE, ECONOMIC LOSS, OR INCIDENTAL OR CONSEQUENTIAL DAMAGES ARISING FROM THE SALE OR DISTRIBUTION OF NELSON PRODUCTS WHETHER FOR BREACH OF WARRANTY HEREUNDER OR FOR NEGLIGENCE OR IN TORT. Some states do not allow limitations on how long an implied warranty will last of the exclusion or limitation on incidental or consequential damages, so the above limitations or exclusions may not apply to you.

If you have any questions concerning the warranty or its application, please write to L.R. Nelson Corporation, One Sprinkler Lane, Peoria, Illinois 61615, U.S.A. Attention: Customer Service.

CLAIMED DEFECTIVE MERCHANDISE POLICY

Products returned to the retailer or distributor and claimed defective must be inspected by the Nelson sales representative to determine warranty compliance. If approval is granted, products will be repaired or replaced or a credit memorandum covering the net purchase price will be issued.